

Applicable Model

R26C
(Wall Mounting)

Drawing Title

Intercom Panel

Drawing Unit

mm

Drawing Scale

Not to scale

**DRAFT
SUBJECT TO
CHANGE**

Last Revised

December 31,2019

Drawing Version

V1.0

Page

1 of 3

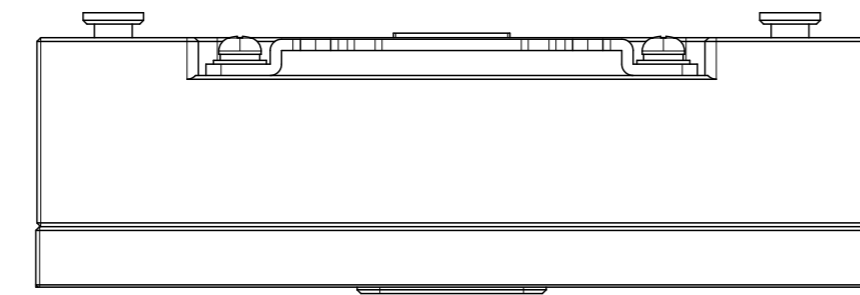

5 TOP VIEW

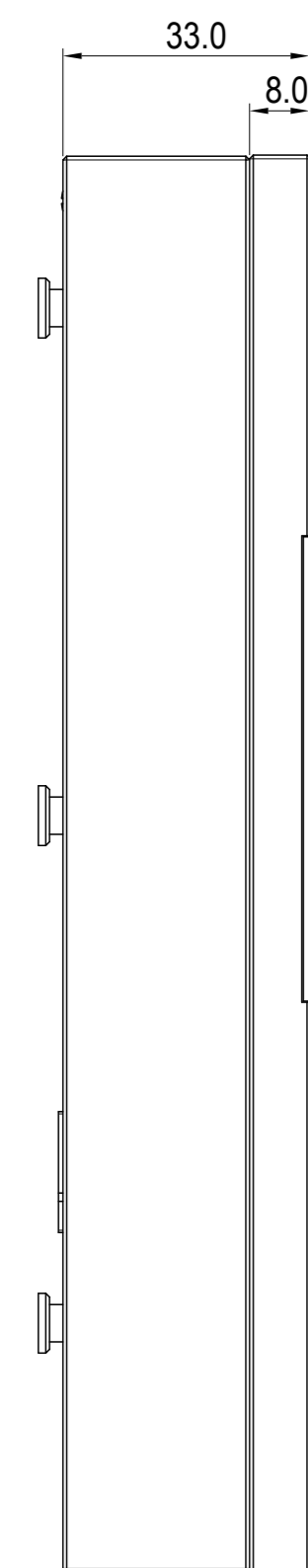

2 RIGHT VIEW

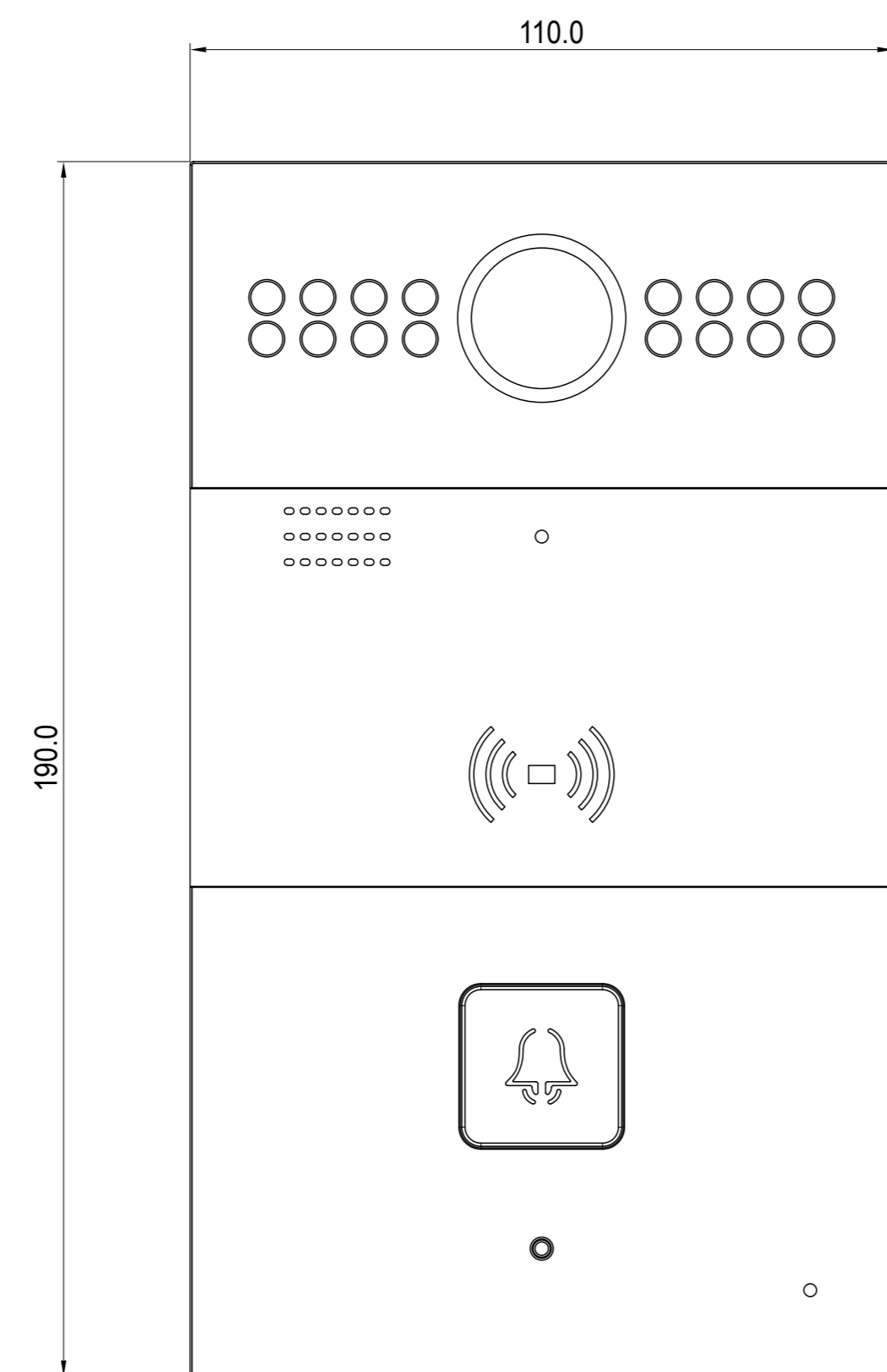

1 FRONT VIEW

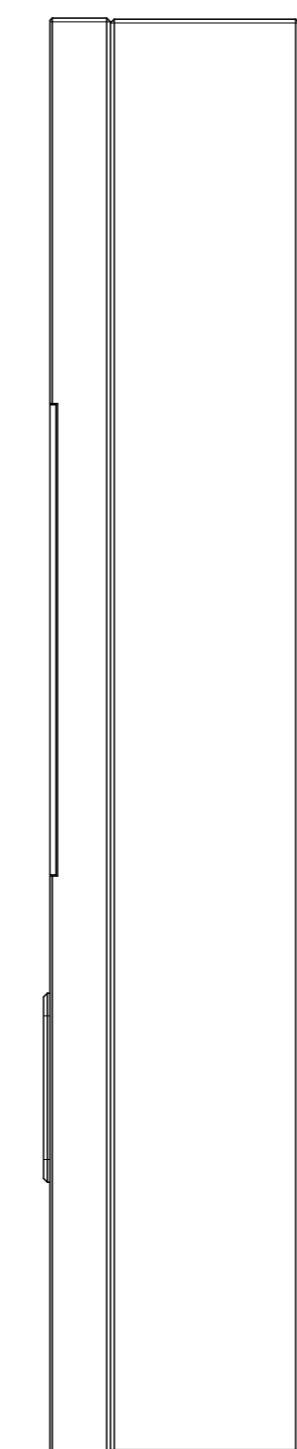

3 LEFT VIEW

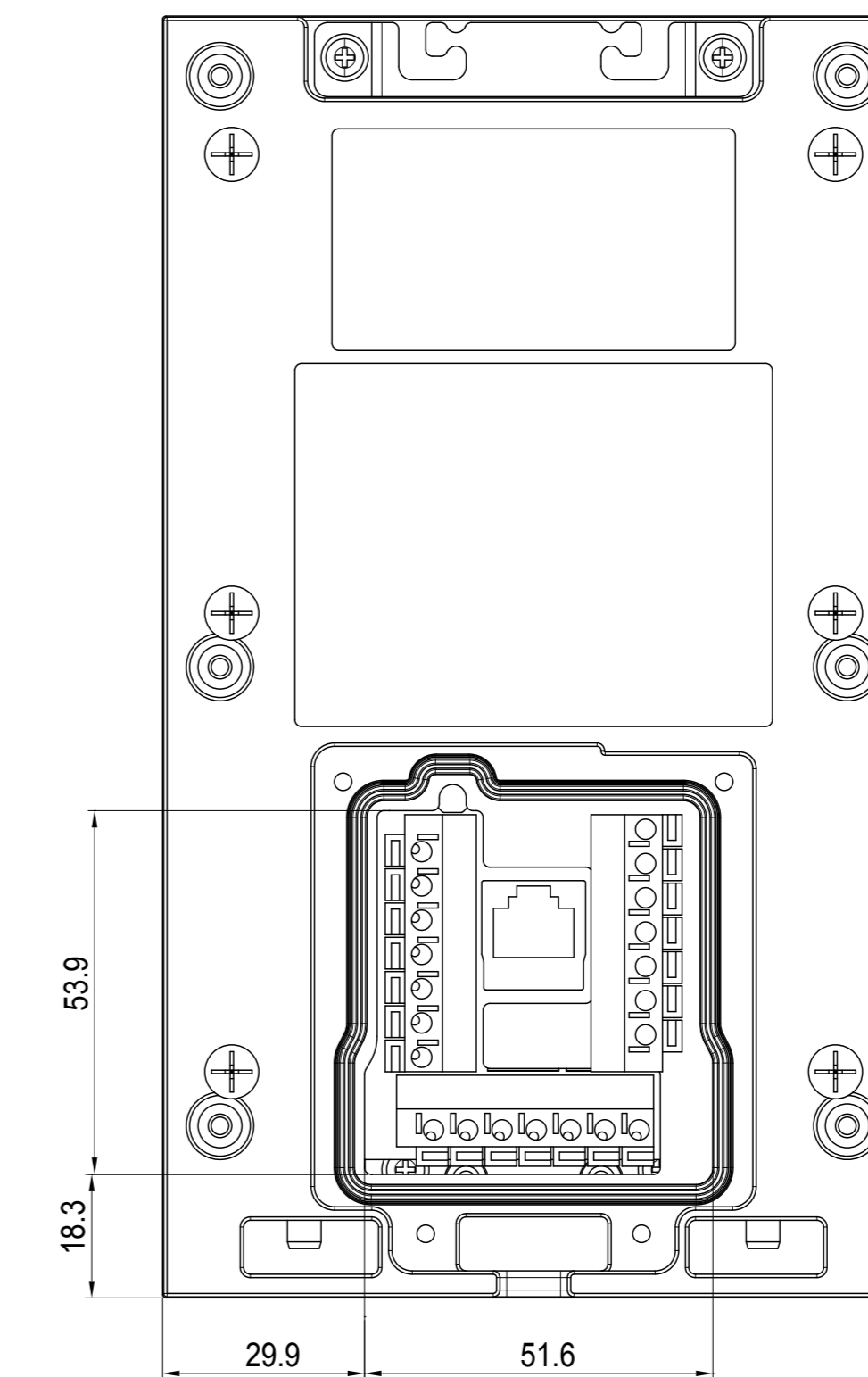

4 BACK VIEW

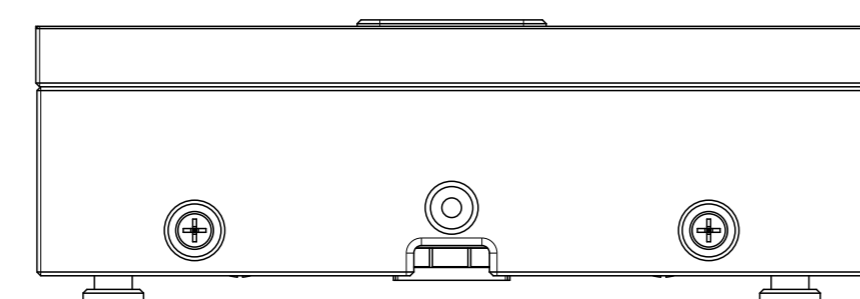

6 BOTTOM VIEW

Applicable Model

R26C
(Wall Mounting)

Drawing Title

Wall Mounting Bracket

Drawing Unit

mm

Drawing Scale

Not to scale

**DRAFT
SUBJECT TO
CHANGE**

Last Revised

December 31,2019

Drawing Version

V1.0

Page

2 of 3

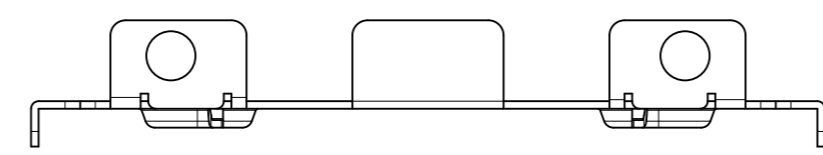

5 TOP VIEW

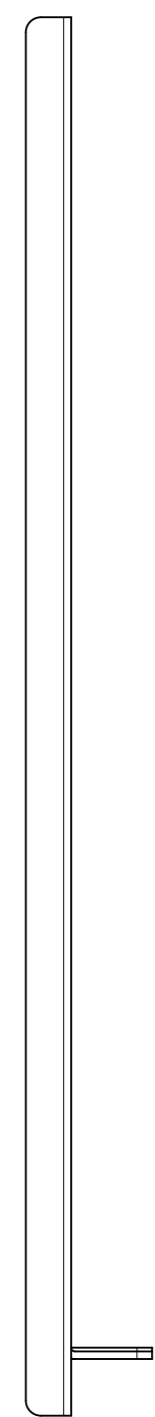

2 RIGHT VIEW

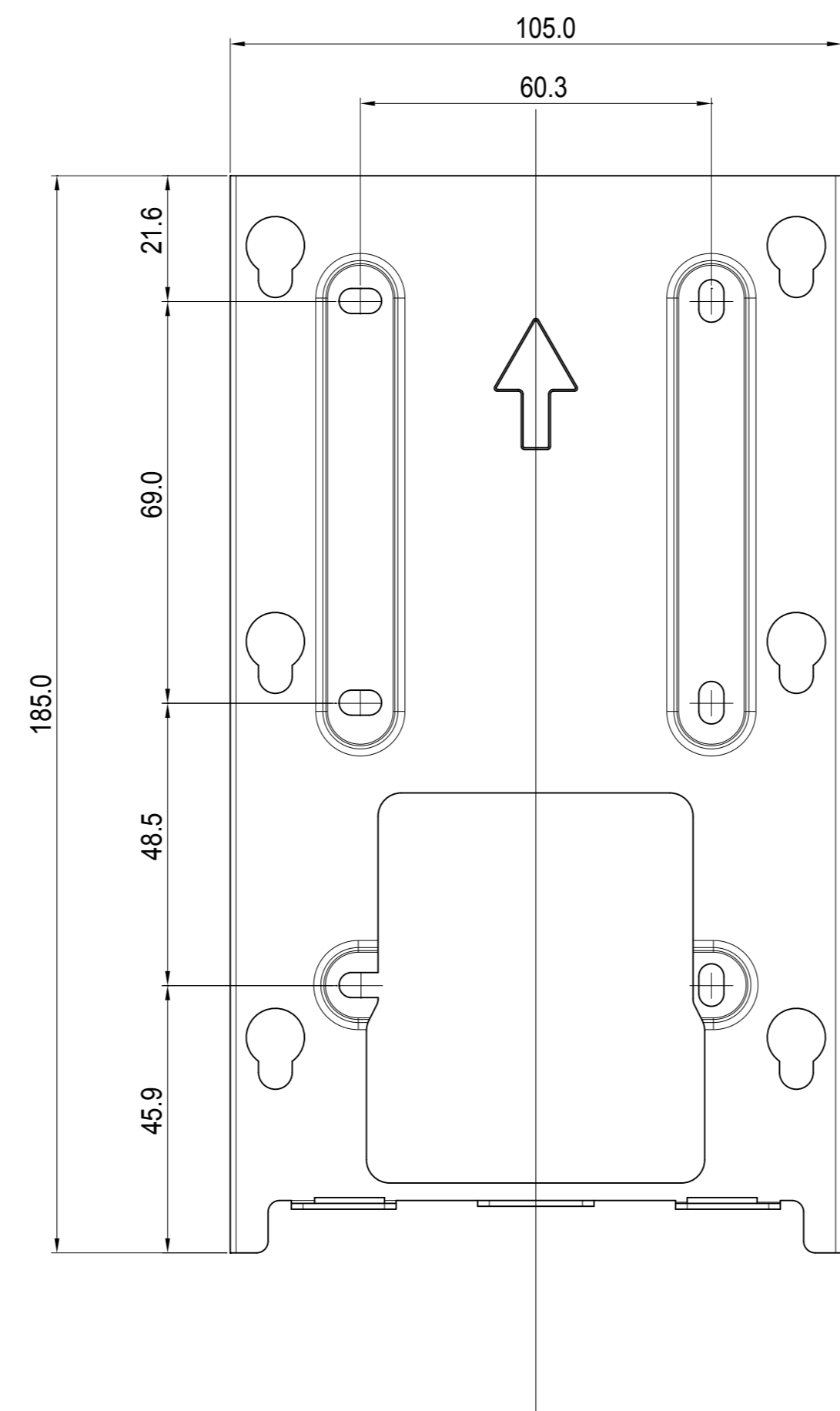

1 FRONT VIEW

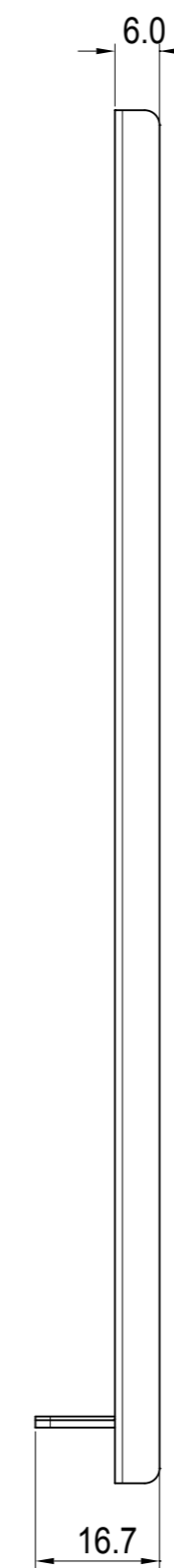

3 LEFT VIEW

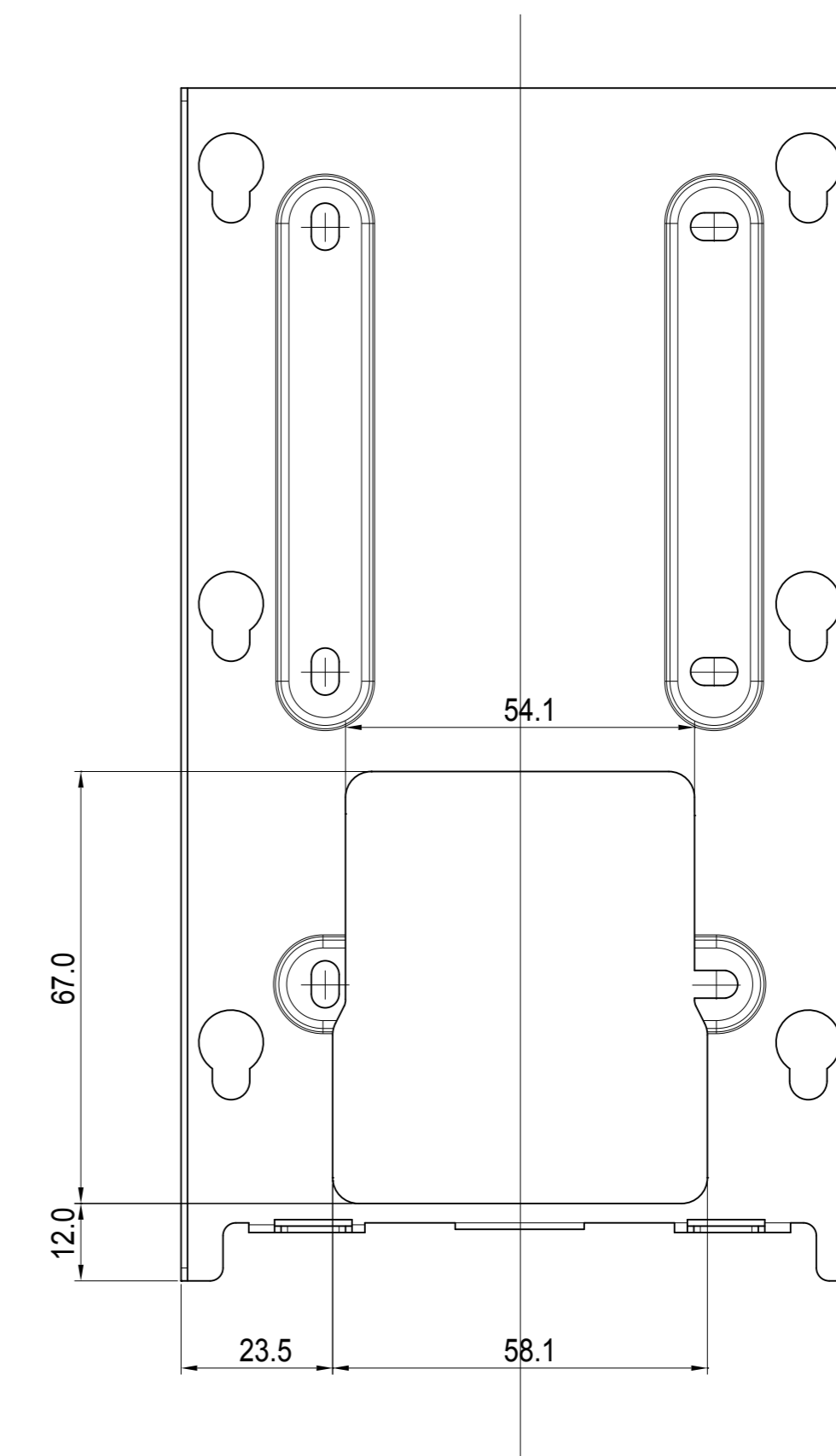

4 BACK VIEW

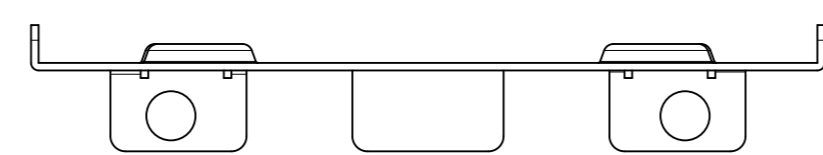

6 BOTTOM VIEW

Applicable Model

R26C
(Wall Mounting)

Drawing Title

Placement

Drawing Unit

mm

Drawing Scale

Not to scale

**DRAFT
SUBJECT TO
CHANGE**

Last Revised

December 31,2019

Drawing Version

V1.0

Page

3 of 3

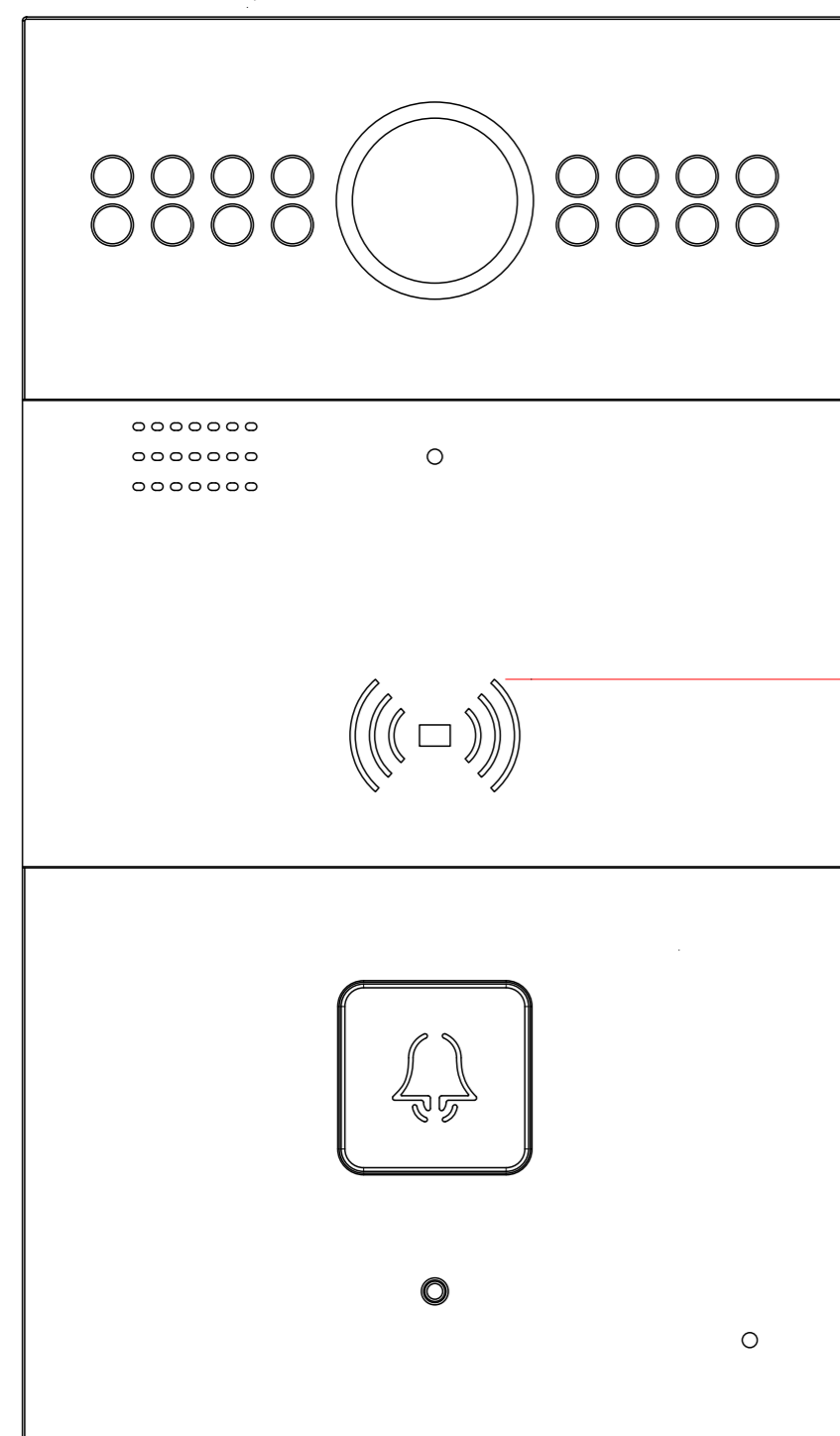

1121mm TO BOTTOM OF PANEL

1220mm MAX TO TOP OF USABLE PARTS

ADA Compliance Requirement

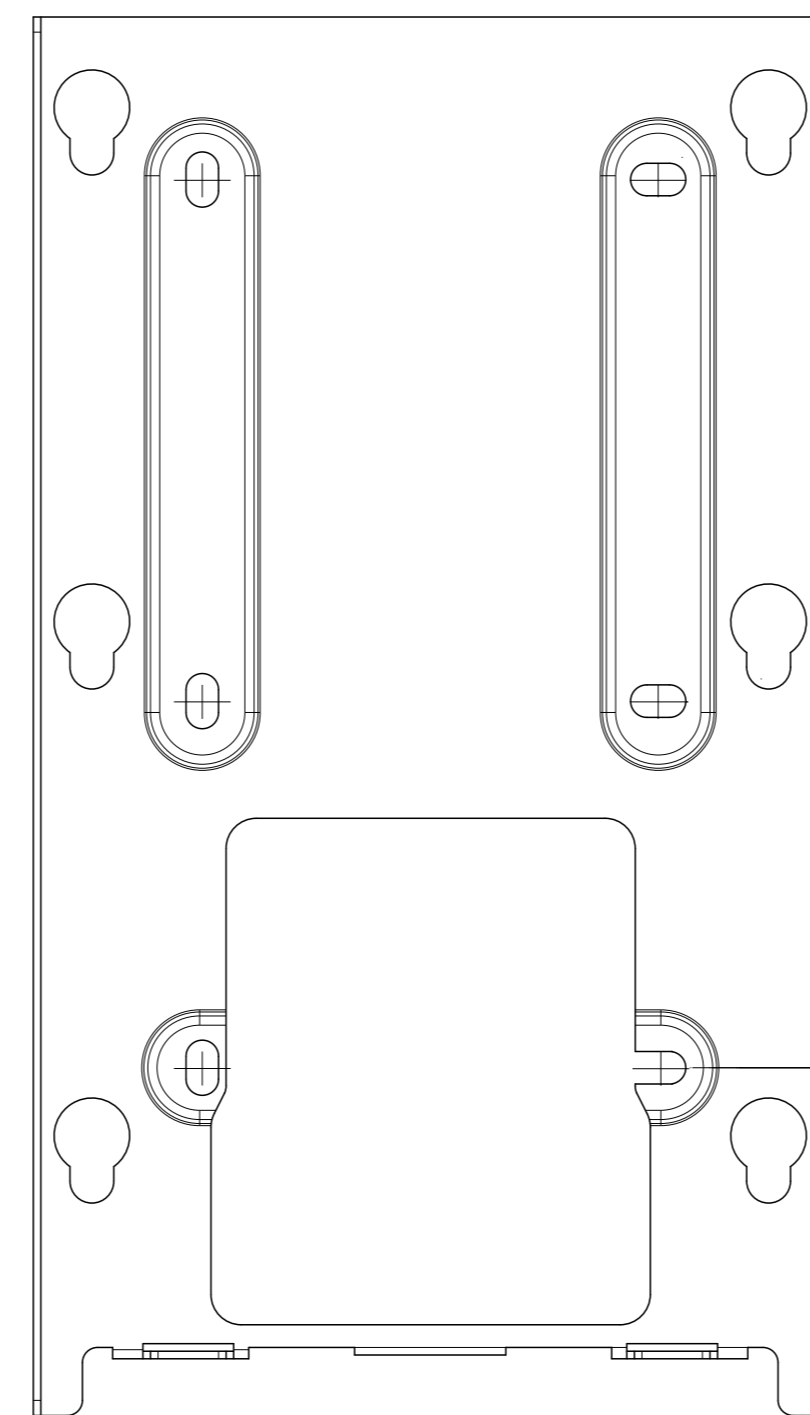
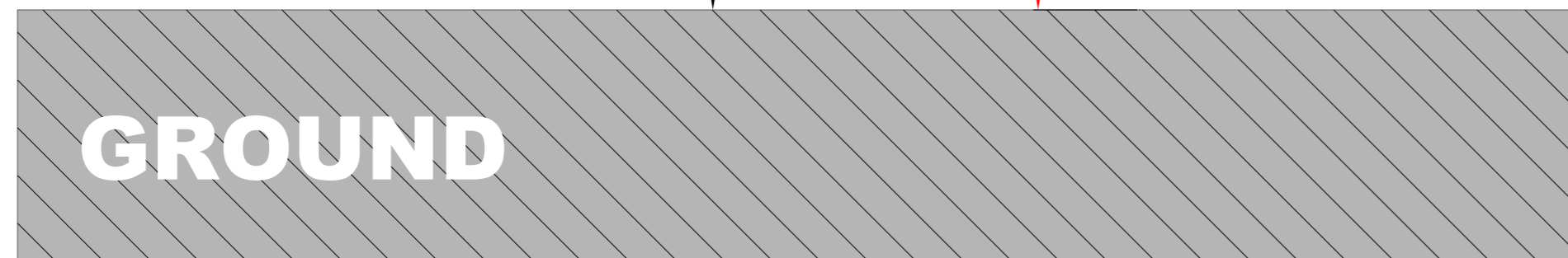

1124mm TO BOTTOM OF BRACKET

1218mm TO SCREW HOLE CENTER OF BRACKET

